

Project Name:		Type:	
Catalog Number:		Date:	

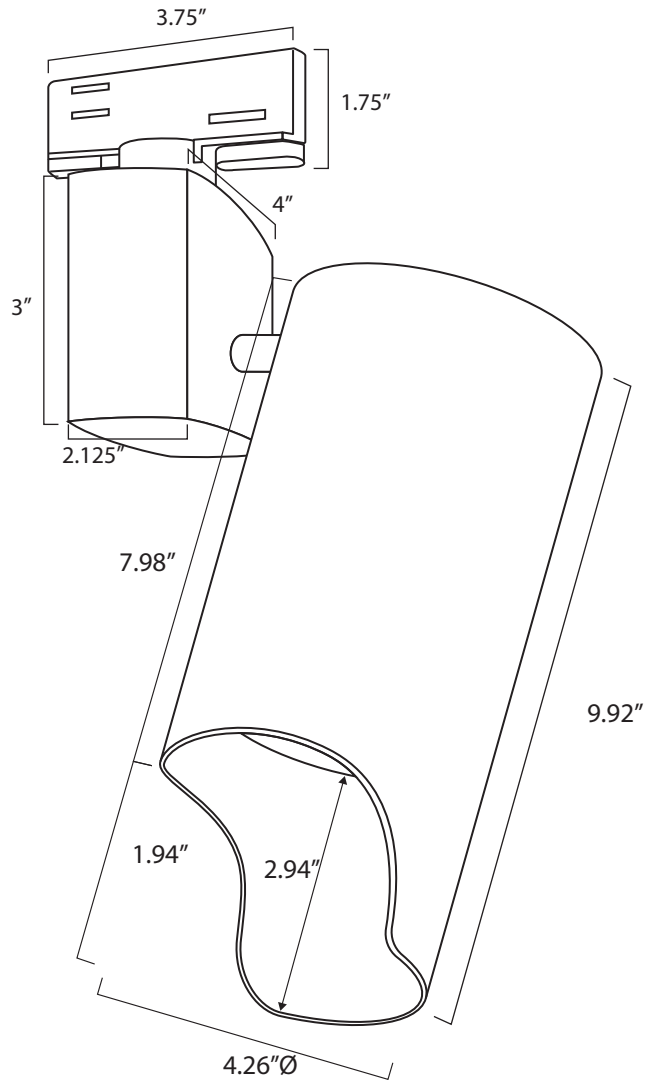
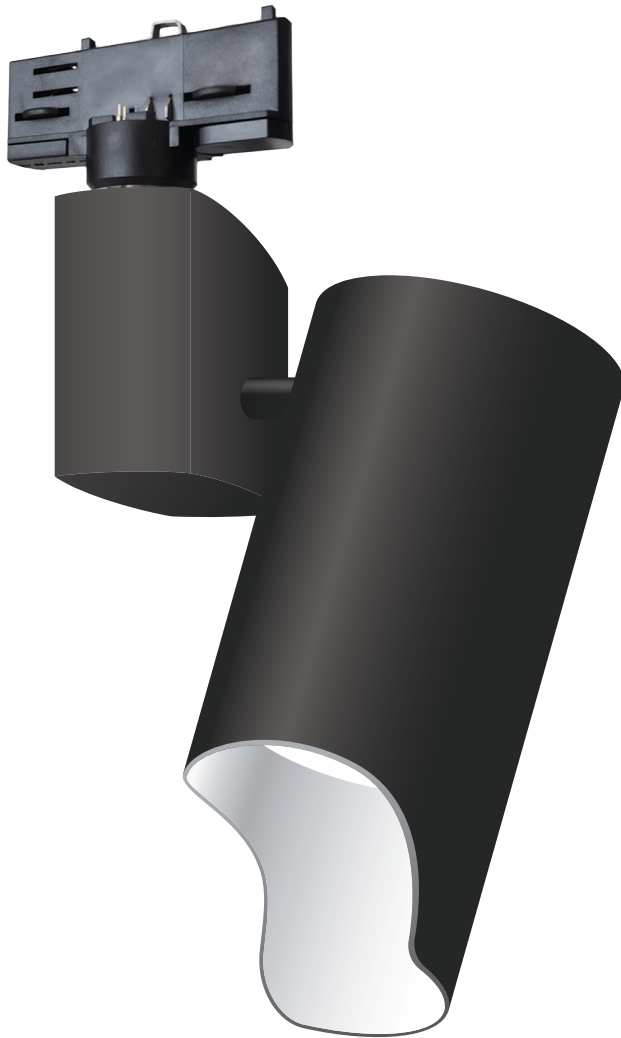

Key Features

- 4.5" OD
- Up to 4 accessories
- Remote transformer option
- Track adapter options
 - 1C - H type 1 circuit
 - 12C - 120V
 - 12C - 277V
- Over 10,000+ fixture custom color finish options
- 100,000+ hr L70 life
- Wall or ceiling mount
- **See Page 3 for C-Clamp Option**

LED Source Details

- CREE XPL2 LED maximum rating 3,000 mA
- Static White Max 1400 mA
 - RGBW 700 mA
 - Fixture operating milliamps = 1,500 mA
 - Fixture Wattage Range = 64W to 68W
 - Fixture Delivered Lumens = 4,500 lumens

Patent Pending

Last revised: 05/13/2024

SDT-838-PAR38-WWS

Vertical Round Wall Wash Scoop

Project Name:		Type:	
Catalog Number:		Date:	

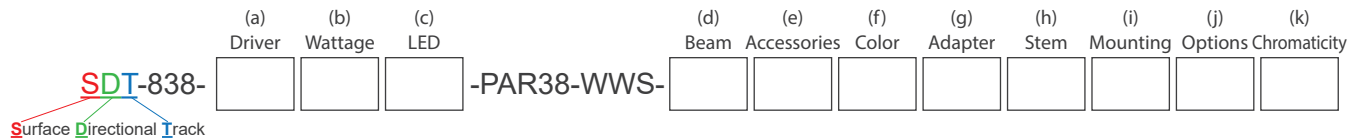

(a) Driver Options

E	= ON/OFF (Electronic)
D	= MLV 1% Dimming (2 wire)
DC12V	= .01% PWM DC dimming (2 wire)
DC24V	= .01% PWM DC dimming (2 wire)
0-10V1	= 0-10V 1% Dimming (3 wire)
RDM DMX	= 8 Bit or 16 Bit, 4 Channel (2 wire with CAT5)

(b) Wattage Options

64W	= 1500 milliamps/4500 lumens, ON/OFF, 0-10V
68W	= 1200 milliamps/3600 lumens, MLV
72W	= 600 milliamps/3000 lumens, RDM DMX RGBW

(c) LED Type Options

CREE XPL2 high intensity = narrow spot (NSP)
 CREE XPL2 high density = spot (SP), narrow flood (NFL), and flood (FL)

(d) Beam Options

NFL	= Narrow Flood	FL	= Flood
-----	----------------	----	---------

(e) Optical and Accessory Options

LS	= Lens Softener - +20% increase in beam width. Shields optical face visually. Softens edges of beam.	
LSL	= Linear Spread Lens - Horizontal or vertical beam elongation.	
WFL	= Wide Flood Lens - Wall washing increases the beam by 50% width with elimination of center beam.	
LV	= Louver - Hexcel louver eliminates all surface brightness. Creates stronger vertical cut off with -20% beam width.	
CHL	= Cross Hiar Louver	
H	= Halogen - 150K warmer. 2700k to 2550K	
DH	= Dimmed Halogen - 300K warmer. 2700k to 2400K	

(f) Fixture Color Options

BLK	= Black
WHT	= White
PWT	= Pewter

Select Custom Color (Review Website for Over 3,300 Color Options)

(g) Track Adapter Options

120	= 2-Circuit, 120V	277	= 2-Circuit, 277V
-----	-------------------	-----	-------------------

(h) Stem Options

S6*	= Stem Size 6"	S18	= Stem Size 18"
S12*	= Stem Size 12"	S24	= Stem Size 24"
CS	= Custom Stem (up to 96")		

*Track only 6" or 12"

(i) Mounting Options

CLP	= C-Clamp
FCP	= Flat Canopy Plate

(j) Options

120V	= 120VAC 60Hz (Standard)
230V	= 230VAC 50Hz (Used in conjunction with 230V track)
277V	= 277VAC 60Hz (Used in conjunction with 277V track)
ES	= Extended Snoot
FCP	= Flat Canopy Plate
CP	= Canopy Plate
C*	= C-Clamp
PL*	= Coil Grounded Plug
LD	= Local Dimming Fixture
DMX*	= .39% to 100% milliamp constant voltage LED driver, dip switch addressable, 3 channel for 27K & 30K, 4 channel for RGBW, CAT5 in & out*
80+	= CRI over 80
90+	= CRI over 90

*DMX is required in RGBA or in any 2 circuits or more.
 Custom colors available - Consult factory for more details

(k) Color Temperature Options

White LED	Colored/Themed LED
22K* = 2200 Kelvin (candlelight color)	UV275** = 275 NM UV virus sterilizer
27K = 2700 Kelvin (incandescent color)	UV365*** = 365 NM UV black light
30K = 3000 Kelvin (halogen color)	UV390*** = 390 NM UV black light
35K = 3500 Kelvin (warm incandescent)	Blue*** = 465 - 485 NM wavelength
40K = 4000 Kelvin (cool incandescent)	Green*** = 520 - 535 NM wavelength
50K = 5000 Kelvin (day white)	Amber*** = 585 - 595NM wavelength
60K = 6500 Kelvin (12 noon sunlight)	Red*** = 620 - 630 NM wavelength
	RGBW3K**** = Red, Green, Blue, White
	RGBW4K**** = Red, Green, Blue, White

*1050 mA or less
 **500 mA
 ***700 mA
 ****Must utilize DMX @ 700 mA

SDT-838-PAR38-WWS

Vertical Round Wall Wash Scoop

Project Name:		Type:	
Catalog Number:		Date:	

Housing

- 100% aluminum construction

Electrical

- Optional - 12V AC remote class 2
- 120V, 230V or 277V

LED

- 3,000 mA rated CREE XPL2 LED – NSP
- Operating at 1600 milliamps = 53% of maximum rated current

LED Driver

- D – 2 wire forward phase .01% LED driver fade to off glow to on
- ED – 2 wire reverse phase 1% LED driver
- DC – 12V or 24V
- 0-10V – 3 wire 1% LED driver
- 16-bit RMD DMX – 65,536 dimming steps fade to off glow to on

Optics

- TIR discrete injection molded polycarbonate precision LED optic
- 45-degree vertical cut off

Installation

Track Adapter

- 2C 120 - 2 circuit 120V
- 2C 277 – 2 circuit 277V

Certification

- UL Damp Listed – IP 52

Warranty

- 5 Year – ED, 0-10V, DMX and colored LED fixtures
- 7 Year – D and White LED fixtures

SDT-838-PAR38-WWS

Vertical Round Wall Wash Scoop

Project Name:		Type:	
Catalog Number:		Date:	

Wattage & Lumen Output

1400 Milliamps - 5000 Lumens	
68W	ON/OFF
	0-10V 1% Dimming
70W	DMX Dimming

3 Step CREE XPL2 LED

Kelvin-CRI	Multiplier
27K-80+ CRI	1
27K-90+ CRI	0.80
30K-80+ CRI	1
30K-90+ CRI	0.85
35K-80+ CRI	105
35K-90+ CRI	0.9
40K-80+ CRI	109
50K-80+ CRI	109
65K-80+ CRI	105
80+ = 84 CRI	
90+ = 94 CRI	

Narrow Flood 21°

2'	5,157 fc	0.7'
4'	1,289 fc	1.5'
6'	573 fc	2.2'
8'	322 fc	3.0'
10'	206 fc	3.7'
12'	143 fc	4.4'



67W PAR38 - 4,266 lm

Zonal Flux and Percentages

Zone	Flux (lm)	%Luminaire
0-30	3369	79.0
0-40	3739	87.7
0-60	4197	98.4
0-90	4266	100.0
40-90	527	12.3
60-90	69	1.6
90-180	0	0.0
0-180	4266	100.0

All planes - Solid (cd)

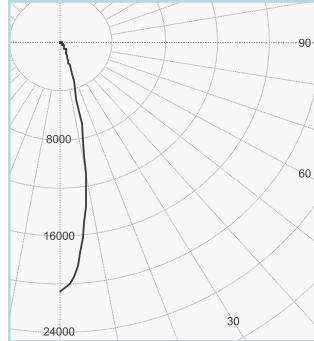

Intensity Summary (cd)

Gamma	All Planes	Flux (lm)
0	20628	
5	17468	1451
10	10916	
15	4848	1396
20	1966	
25	1066	522
30	764	
35	582	370
40	476	
45	381	295
50	291	
55	177	163
60	103	
65	73	65
70	14	
75	3	4
80	1	
85	0	1
90	0	

Clarté Lighting SDT-838-PAR38-WWS

Vertical Round Wall Wash Scoop

TM-30 Color Metrics

Project Name:		Type:	
Catalog Number:		Date:	

Clarté Lighting 3000K 80+ CRI Color Metrics

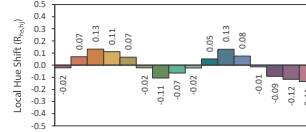
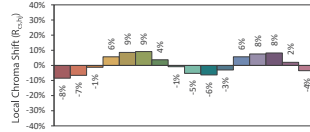
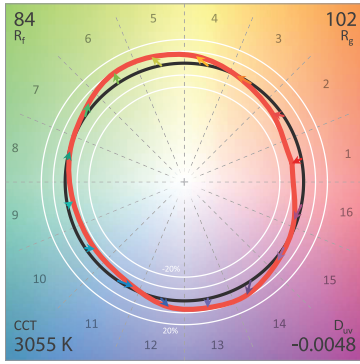

CIE 13.3-1995
(CRI)
R_a 86
R_g 29

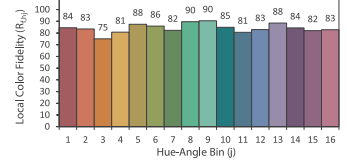
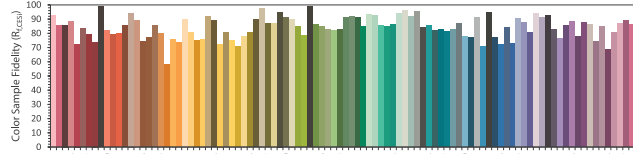

Clarté Lighting 3000K 90+ CRI Color Metrics

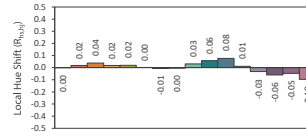
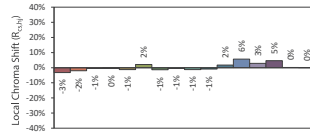
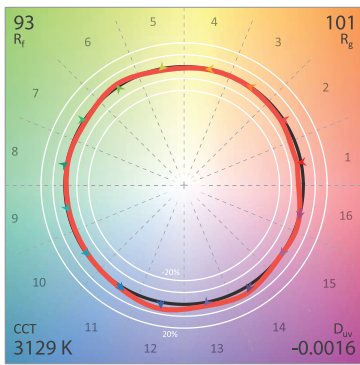

CIE 13.3-1995
(CRI)
R_a 95
R_g 74

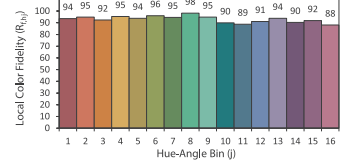
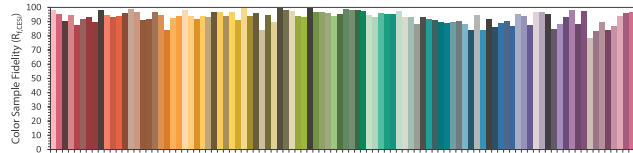

Clarté Lighting 3000K 90+ CRI Halogen Lens (H) Color Metrics

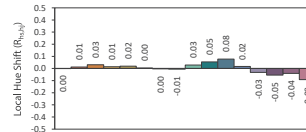
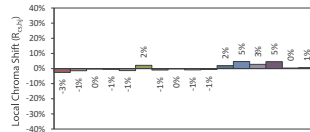
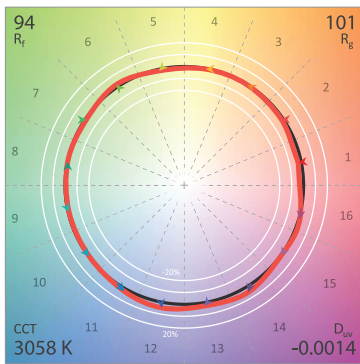

CIE 13.3-1995
(CRI)
R_a 96
R_g 79

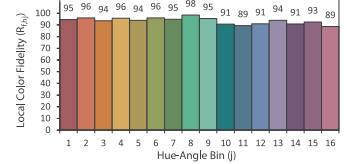
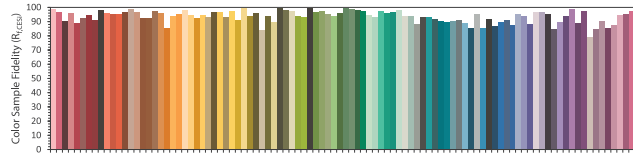

Clarté Lighting 3000K 90+ CRI Dimmed Halogen Lens (DH) Color Metrics

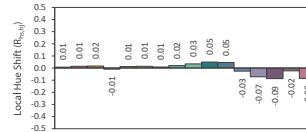
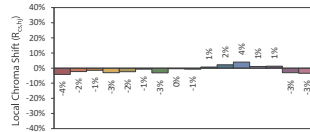
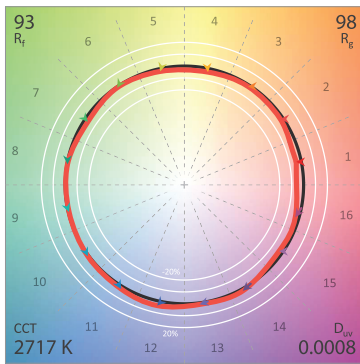

CIE 13.3-1995
(CRI)
R_a 95
R_g 64

