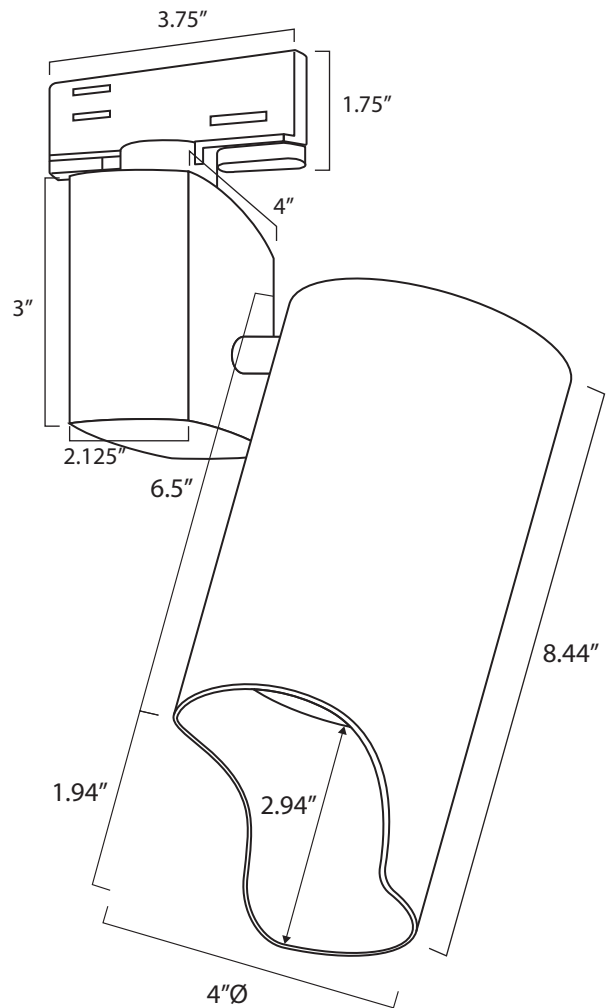
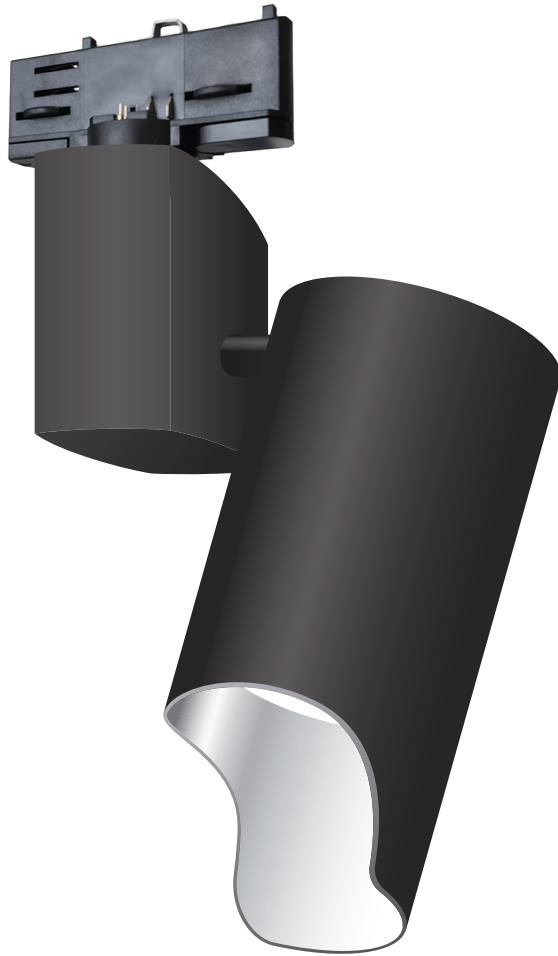

Project Name:		Type:	
Catalog Number:		Date:	

**Key Features**

- 4" OD
- Up to 4 accessories
- Remote transformer optoin
- Over 10,000+ fixture custom color finish options
- 100,000+ hr L70 life
- Wall or ceiling mount

LED Source Details

CREE XML2 LED maximum rating 3,000 mA

- Fixture operating milliamps = 700 mA – 1600 mA
- Operating 23% - 53% of rated value
- Fixture delivered lumens = up to 3,911 lumens

Last revised: 05/13/2024

Project Name:		Type:	
Catalog Number:		Date:	

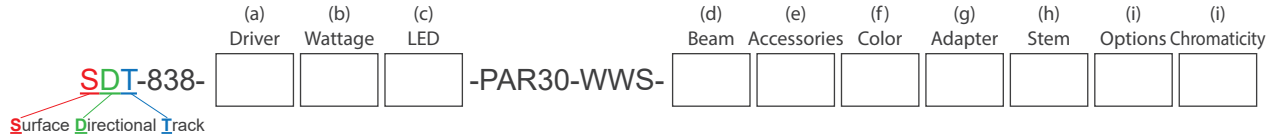

(a) Driver Options

E	= ON/OFF (Electronic)
D	= MLV 1% Dimming (2 wire)
DC12V	= .01% PWM DC dimming (2 wire)
DC24V	= .01% PWM DC dimming (2 wire)
0-10V1	= 0-10V 1% Dimming (3 wire)
RDM DMX	= 8 Bit or 16 Bit, 4 Channel (2 wire with CAT5)

(b) Wattage Options

27W (450mA, 1300 Lumens) = ON/OFF
 35W (700mA, 2000 Lumens) = MLV <1% Dimming
 44W (1000mA, 2800 Lumens) = ON/OFF
 48W (3300mA, 3300 Lumens) = MLV <1% Dimming, ON/OFF, 0-10V 1%, Lutron, DMX

(c) LED Type Options

XLED = Cree XPL2 LED @ All Wattages

(d) Beam Options

NFL = Narrow Flood FL = Flood

(e) Optical and Accessory Options

LS	= Lens Softener - +20% increase in beam width. Shields optical face visually. Softens edges of beam.	
LSL	= Linear Spread Lens - Horizontal or vertical beam elongation.	
WFL	= Wide Flood Lens - Wall washing increases the beam by 50% width with elimination of center beam.	
LV	= Louver - Hexcel louver eliminates all surface brightness. Creates stronger vertical cut off with -20% beam width.	
CHL	= Cross Hair Louver	
H	= Halogen - 150K warmer. 2700k to 2550K	
DH	= Dimmed Halogen - 300K warmer. 2700k to 2400K	

(f) Fixture Color Options

BLK = Black
 WHT = White
 PWT = Pewter
 Select Custom Color (Review Website for Over 3,300 Color Options)

(g) Track Adapter Options

2C 120V	= 2 circuit 120V	2C 230	= 2 circuit 230V
2C 277	= 2 circuit 277V		

(h) Stem Options

S6*	= Stem Size 6"	S18	= Stem Size 18"
S12*	= Stem Size 12"	S24	= Stem Size 24"
CS	= Custom Stem (up to 96")		

*Track only 6" or 12"

(i) Options

80+	= CRI over 80
90+	= CRI over 90
120V	= 120VAC 60Hz (Standard)
230V	= 230VAC 50Hz (Used in conjunction with 230V track)
277V	= 277VAC 60Hz (Used in conjunction with 277V track)
FCP	= Flat Canopy Plate
CP	= Canopy Plate
C*	= C-Clamp
PL*	= Coil Grounded Plug
LD	= Local Dimming Fixture
DMX*	= .39% to 100% milliamp constant voltage LED driver, dip switch addressable, 3 channel for 27K & 30K, 4 channel for RGBW, CAT5 in & out*

*DMX is required in RGBA or in any 2 circuits or more.
 Custom colors available - Consult factory for more details

(j) Color Temperature Options

White LED	Colored/Themed LED
22K* = 2200 Kelvin (candlelight color)	UV275** = 275 NM UV virus sterilizer
27K = 2700 Kelvin (incandescent color)	UV365*** = 365 NM UV black light
30K = 3000 Kelvin (halogen color)	UV390*** = 390 NM UV black light
35K = 3500 Kelvin (warm incandescent)	Blue*** = 465 - 485 NM wavelength
40K = 4000 Kelvin (cool incandescent)	Green*** = 520 - 535 NM wavelength
50K = 5000 Kelvin (day white)	Amber*** = 585 - 595NM wavelength
60K = 6500 Kelvin (12 noon sunlight)	Red*** = 620 - 630 NM wavelength
	RGBW3K**** = Red, Green, Blue, White
	RGBW4K**** = Red, Green, Blue, White

*1050 mA or less **500 mA
 ***700 mA
 ****Must utilize DMX @ 700 mA

Project Name:		Type:	
Catalog Number:		Date:	

Housing

- 100% aluminum construction

Electrical

- Optional - 12V AC remote class 2
- 120V, 230V or 277V

LED

- 3,000mA maximum rated CREE XPL2 LED
- Operates between 450 to 1200mA
- 15% to 40% of rated mA

LED Driver

- D – 2 wire forward phase .01% LED driver fade to off glow to on
- AC – 2 wire 12V AC

Optics

- TIR discrete injection molded polycarbonate precision LED optic
- 45-degree vertical cut off

Installation

Track Adapter

- 2C 120 - 2 circuit 120V
- 2C 277 – 2 circuit 277V

Certification

- UL Damp Listed – IP 52

Warranty

- 7 Year – D and White LED fixtures

SDT-838-PAR30-WWS

Vertical Round Wall Wash Scoop

Project Name:		Type:	
Catalog Number:		Date:	

Wattage & Lumen Output

700 Milliamps - 1800 Lumens 22W	1000 Milliamps - 2500 Lumens 33W	1200 Milliamps - 3100 Lumens 42W	1400 Milliamps - 3400 Lumens 46W	1600 Milliamps - 3900 Lumens 55W
---	--	--	--	--

3 Step CREE XPL2 LED

Kelvin-CRI	Multiplier
27K-80+ CRI	1
27K-90+ CRI	0.80
30K-80+ CRI	1
30K-90+ CRI	0.85
35K-80+ CRI	1.05
35K-90+ CRI	0.9
40K-80+ CRI	1.09
50K-80+ CRI	1.09
65K-80+ CRI	1.05
80+ = 84 CRI	
90+ = 94 CRI	

Spot 19°

4'	1,370 fc	1.4'
6'	609 fc	2.1'
8'	342 fc	2.8'
10'	219 fc	3.5'
12'	152 fc	4.2'
20'	55 fc	7.0'
26.7'	31 fc	9.4'
40'	14 fc	14.0'

55W PAR30 - 3,607 lm

Narrow Spot 12°

2'	11,097 fc	0.4'
4'	2,774 fc	0.9'
6'	1,233 fc	1.3'
8'	694 fc	1.7'
10'	444 fc	2.1'
12'	308 fc	2.6'

55W PAR30 - 3,372 lm

Narrow Flood 22°

4'	1,192 fc	1.5'
6'	530 fc	2.2'
8'	298 fc	2.9'
10'	191 fc	3.6'
12'	132 fc	4.4'
20'	48 fc	7.3'
26.7'	27 fc	9.7'
40'	12 fc	14.5'

55W PAR30 - 3,481 lm

Flood 32°

4'	403 fc	2.3'
6'	179 fc	3.4'
8'	101 fc	4.5'
10'	65 fc	5.7'
12'	45 fc	6.8'
20'	16 fc	11.3'
26.7'	9 fc	15.1'
40'	4 fc	22.7'

55W PAR30 - 3,245 lm

Intensity Summary (cd)

Gamma	All Planes	Flux (lm)
0	44389	
5	27240	1963
10	9044	
15	2798	872
20	854	
25	440	214
30	285	
35	211	135
40	172	
45	133	105
50	102	
55	57	56
60	45	
65	29	25
70	3	
75	1	1
80	1	
85	0	0
90	0	

Intensity Summary (cd)

Gamma	All Planes	Flux (lm)
0	19074	
5	16233	1332
10	9848	
15	5190	1461
20	2626	
25	1289	620
30	632	
35	329	220
40	211	
45	146	114
50	98	
55	57	55
60	42	
65	27	26
70	14	
75	9	10
80	6	
85	2	3
90	0	

Intensity Summary (cd)

Gamma	All Planes	Flux (lm)
0	6451	
5	5949	529
10	4754	
15	3424	944
20	2326	
25	1552	720
30	1033	
35	639	405
40	368	
45	227	181
50	145	
55	88	83
60	58	
65	39	39
70	21	
75	14	15
80	9	
85	4	4
90	0	

Zonal Flux and Percentages

Zone	Flux (lm)	%Luminaire
0-30	3049	90.4
0-40	3784	94.4
0-60	3345	99.2
0-90	3372	100.0
40-90	188	5.6
60-90	27	0.8
90-180	0	0.0
0-180	3372	100.0

Zonal Flux and Percentages

Zone	Flux (lm)	%Luminaire
0-30	3413	88.8
0-40	3633	94.6
0-60	3802	99.0
0-90	3840	100.0
40-90	208	5.4
60-90	39	1.0
90-180	0	0.0
0-180	3841	100.0

Zonal Flux and Percentages

Zone	Flux (lm)	%Luminaire
0-30	2193	75.1
0-40	2598	89.0
0-60	2862	98.0
0-90	2919	100.0
40-90	321	11.0
60-90	58	2.0
90-180	0	0.0
0-180	2919	100.0

All planes - Solid (cd)

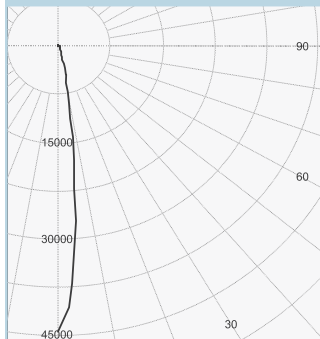

All planes - Solid (cd)

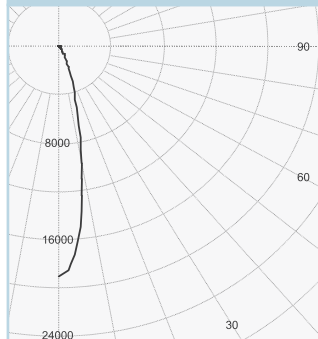

All planes - Solid (cd)

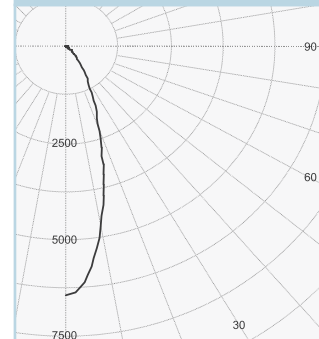

Clarté Lighting SDT-838-PAR30-WWS

Vertical Round Wall Wash Scoop

TM-30 Color Metrics

Project Name:		Type:	
Catalog Number:		Date:	

Clarté Lighting 3000K 80+ CRI Color Metrics

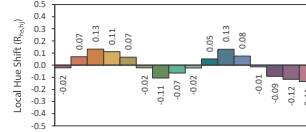
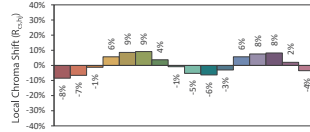
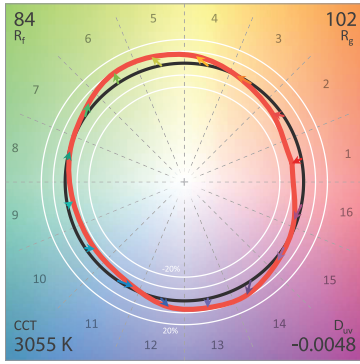

CIE 13.3-1995
(CRI)
R_a 86
R₉ 29

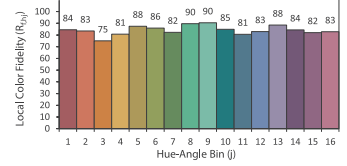
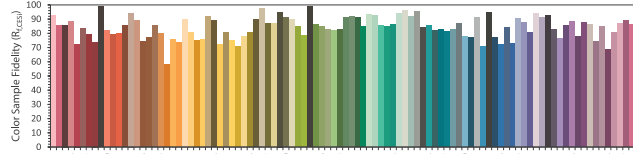

Clarté Lighting 3000K 90+ CRI Color Metrics

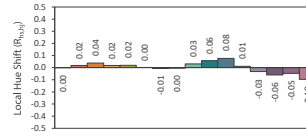
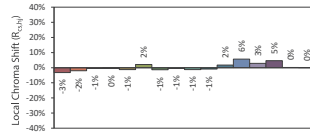
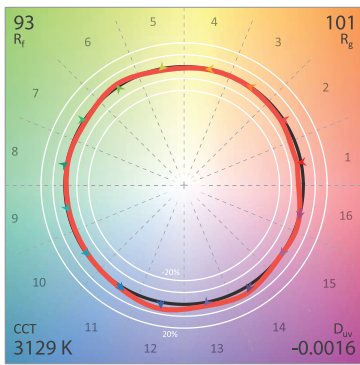

CIE 13.3-1995
(CRI)
R_a 95
R₉ 74

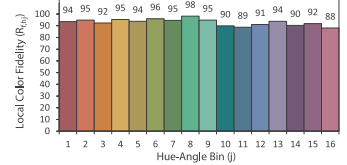
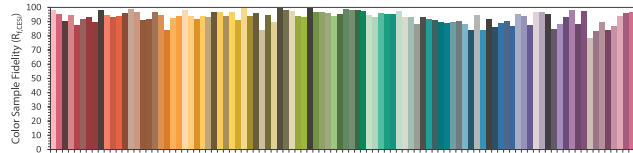

Clarté Lighting 3000K 90+ CRI Halogen Lens (H) Color Metrics

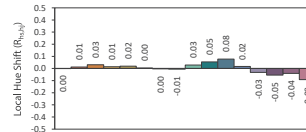
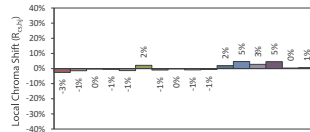
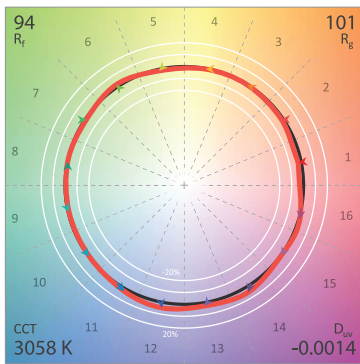

CIE 13.3-1995
(CRI)
R_a 96
R₉ 79

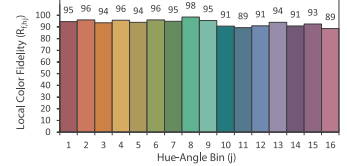
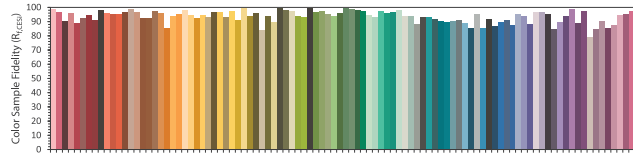

Clarté Lighting 3000K 90+ CRI Dimmed Halogen Lens (DH) Color Metrics

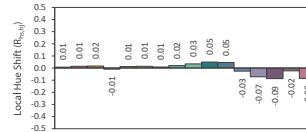
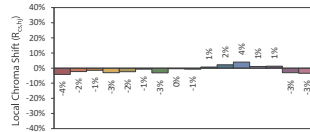
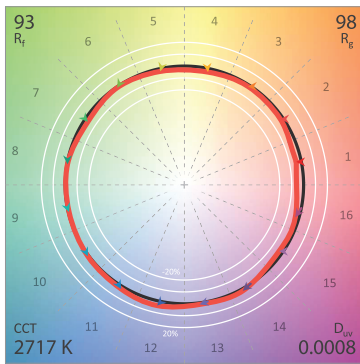

CIE 13.3-1995
(CRI)
R_a 95
R₉ 64

